

Federal Series

3535 3W LC
Warm White

Datasheet

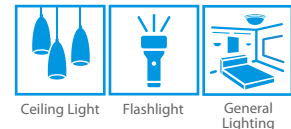
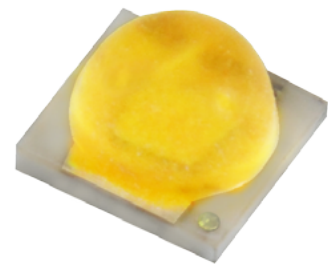

Features :

- High lumen performance
- High efficiency package
- Standard 3535 package with existing design
- Level 1 on JEDEC moisture sensitivity analysis
- Maximum drive current : 700 mA
- RoHS compliant

Typical Applications :

- | | |
|-----------------------------|-----------------------|
| ■ Reading lights | ■ Portable flashlight |
| ■ Up-lights and Down-lights | ■ LCD Backlights |
| ■ General lighting | ■ Contour lights |
| ■ Ceiling lights | ■ Garden lighting |

Table of Contents

General Information.....	3
Absolute Maximum Ratings	4
Characteristics	4
Luminous Flux BIN Code.....	5
Voltage BIN Code.....	5
Color BIN Code	6
Mechanical Dimensions.....	8
Characteristic Curve	10
Reflow Profile	15
Product Packaging Information.....	16
Revision History	18
About Edison Opto	18

General Information

Introduction

Federal 3535 is a surface mount, compact, high brightness LED that is built for various illumination needs. A single Warm White Federal 3535 can deliver typical luminous flux of 115 lm while driving at 350mA suitable for any kind of lighting sources, including general illumination, flashlights, streetlights, spotlights, industrial and commercial lightings. The small physical dimension can free customers from any constrains or limitations in these fields of applications. Furthermore, the reflow-solderable nature of Federal 3535 provides an easy path towards the optimum thermal management to achieve a promising reliability. In conclusion, Federal 3535 offers you an extraordinary LED experience.

Ordering Code Format

2
X1
F
X2
X0
X3
03
X4
WW
X5
xx
X6
F02
X7
xxx
X8

X1		X2		X3		X4		X5	
Type		Component		Series		Wattage		Color	
2	Emitter	F	Federal	X0	3535	03	3W	WW	Warm White

X6		X7		X8	
Internal code		PCB Board		Serial Number	
-	-	F02	3535	-	-

Absolute Maximum Ratings

($T_J = 25^\circ\text{C}$)

Parameter	Symbol	Value	Units
DC Forward Current	I_F	700	mA
Reverse Voltage ^[1]	V_R	Note 1	V
LED Junction Temperature ^[2]	T_J	125	$^\circ\text{C}$
Operating Temperature	-	-40 ~ +85	$^\circ\text{C}$
Storage Temperature	-	-40 ~ +85	$^\circ\text{C}$
ESD Sensitivity (HBM)	-	8,000	V
Allowable Reflow Cycles	-	3	cycles
Soldering Temperature	-	260	$^\circ\text{C}$

Notes:

- LEDs are not designed to drive in reverse bias.
- Proper current derating must be observed to maintain junction temperature below the maximum.

Characteristics

($I_F = 350\text{mA}$; $T_J = 25^\circ\text{C}$)

Parameter	Symbol	Value	Units
Viewing Angle	(Typ.) $2\theta_{1/2}$	105	Degree
Thermal resistance	-	6.1	$^\circ\text{C}/\text{W}$
CRI	-	80	-
CCT	-	2,670 - 3,800	K
		Level 1	
		Floor Life	
		Conditions: $\leq 30^\circ\text{C}$ / 85% RH	
JEDEC Moisture Sensitivity	-	Soak Requirements(Standard)	-
		Time (hours): 168+5/-0	
		Conditions: 85°C / 85% RH	

Note:

Viewing angle is measured with accuracy of $\pm 10\%$.

Luminous Flux BIN Code

(T_j = 25°C)

Color	Group	Luminous Flux @350mA (lm)		Luminous Flux @700mA (lm)		Order Code
		min	max	min	max	
Warm White	CA	95	110	160.5	186.0	2FX003WW73F02008
	CB	110	125	186.0	211.5	
	CC	125	140	211.5	236.5	

Note:

The luminous flux performance is guaranteed within published operating conditions. Edison Opto maintains a tolerance of ±10% on flux measurements.

Voltage BIN Code

(I_f = 350mA; T_j = 25°C)

Group	Min. Voltage (V)	Max. Voltage (V)
V00	2.5	2.8
V01	2.8	3.1
V02	3.1	3.4

Note:

Forward voltage measurement allowance is ± 0.06V.

Color BIN Code

($I_f = 350\text{mA}; T_j = 25^\circ\text{C}$)

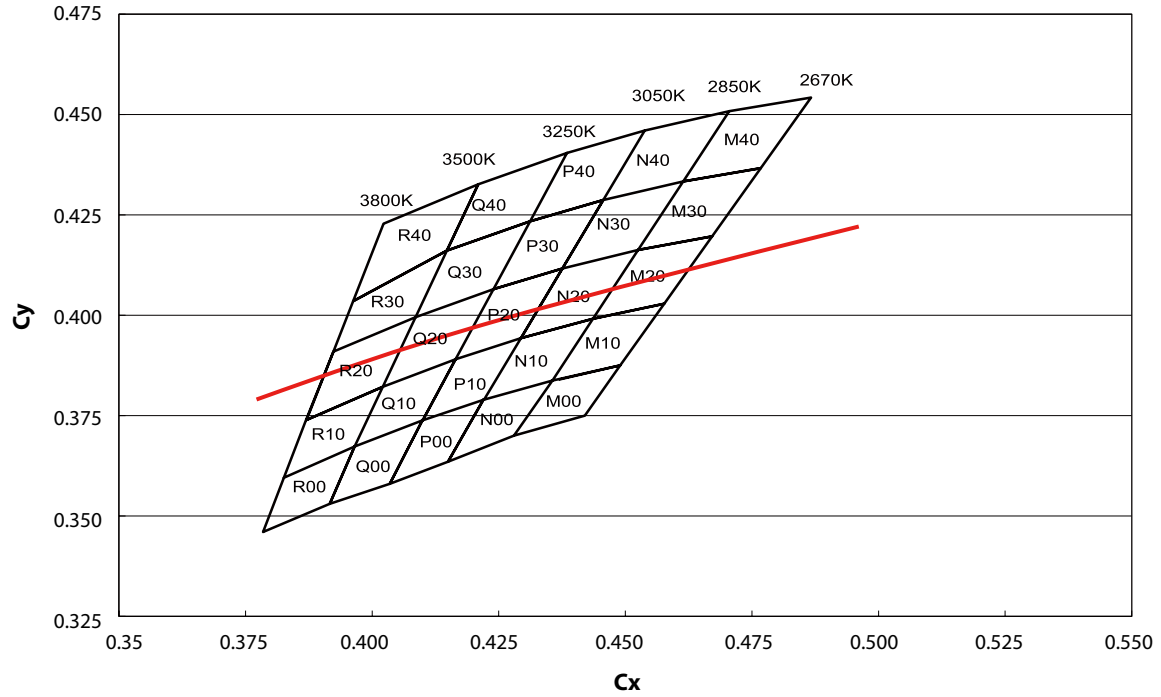

Warm White

R00		R10		R20		R30		R40	
Cx	Cy	Cx	Cy	Cx	Cy	Cx	Cy	Cx	Cy
0.3966	0.3673	0.3871	0.3739	0.3924	0.3909	0.4086	0.3995	0.4023	0.4228
0.3917	0.3530	0.4021	0.3822	0.3871	0.3739	0.3924	0.3909	0.4209	0.4326
0.3785	0.3460	0.3966	0.3673	0.4021	0.3822	0.3963	0.4035	0.4148	0.4161
0.3826	0.3595	0.3826	0.3595	0.4086	0.3995	0.4148	0.4161	0.3963	0.4035

Q00		Q10		Q20		Q30		Q40	
Cx	Cy	Cx	Cy	Cx	Cy	Cx	Cy	Cx	Cy
0.4100	0.3740	0.4165	0.3890	0.4086	0.3995	0.4086	0.3995	0.4385	0.4404
0.4035	0.3580	0.4100	0.3738	0.4240	0.4065	0.4148	0.4161	0.4312	0.4234
0.3917	0.3530	0.4021	0.3822	0.4165	0.3890	0.4312	0.4234	0.4148	0.4161
0.3966	0.3673	0.3966	0.3673	0.4021	0.3822	0.4240	0.4065	0.4209	0.4326

P00		P10		P20		P30		P40	
Cx	Cy	Cx	Cy	Cx	Cy	Cx	Cy	Cx	Cy
0.4220	0.3790	0.4294	0.3943	0.4240	0.4065	0.4312	0.4234	0.4385	0.4404
0.4150	0.3635	0.4221	0.3790	0.4376	0.4116	0.4456	0.4287	0.4538	0.4460
0.4035	0.3580	0.4100	0.3738	0.4294	0.3943	0.4376	0.4116	0.4456	0.4287
0.4100	0.3740	0.4165	0.3890	0.4165	0.3890	0.4240	0.4065	0.4312	0.4234

N00		N10		N20		N30		N40	
Cx	Cy	Cx	Cy	Cx	Cy	Cx	Cy	Cx	Cy
0.4356	0.3837	0.4294	0.3943	0.4376	0.4116	0.4614	0.4333	0.4538	0.4460
0.4280	0.3700	0.4436	0.3991	0.4294	0.3943	0.4525	0.4162	0.4705	0.4508
0.4150	0.3635	0.4356	0.3837	0.4436	0.3991	0.4376	0.4116	0.4614	0.4333
0.4220	0.3790	0.4221	0.3790	0.4525	0.4162	0.4456	0.4287	0.4456	0.4287

M00		M10		M20		M30		M40	
Cx	Cy	Cx	Cy	Cx	Cy	Cx	Cy	Cx	Cy
0.4490	0.3875	0.4436	0.3991	0.4525	0.4162	0.4614	0.4333	0.4705	0.4508
0.4420	0.3750	0.4577	0.4029	0.4671	0.4196	0.4767	0.4366	0.4866	0.4542
0.4280	0.3700	0.4490	0.3875	0.4577	0.4029	0.4671	0.4196	0.4767	0.4366
0.4356	0.3837	0.4356	0.3837	0.4456	0.4287	0.4525	0.4162	0.4614	0.4333

Notes:

1. Cx / Cy tolerance: ± 0.005
2. Color rendering index CRI Tolerance: ± 2

Mechanical Dimensions

Component

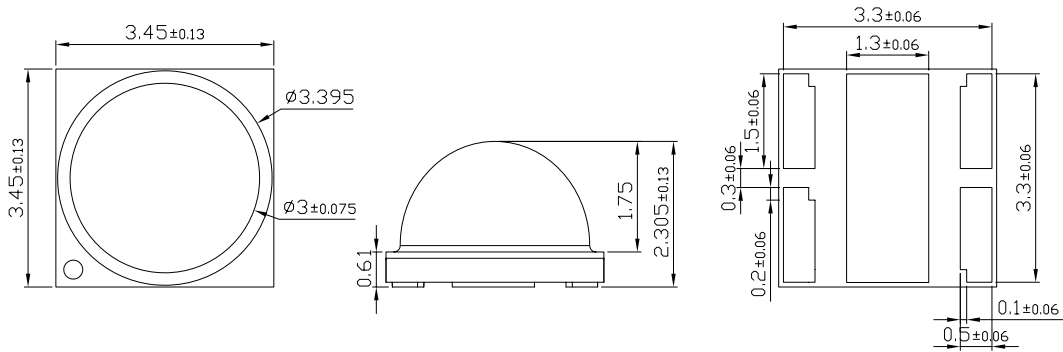

Unless otherwise specified tolerance: ± 0.1
Unit: mm

Note:

1. Drawings are not to scale.

Circuit

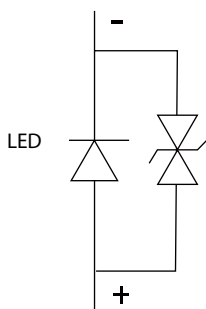

Ceramic Layout

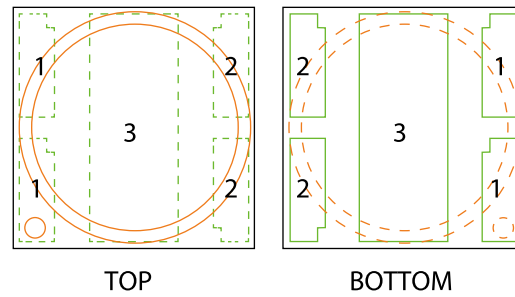

Pad Configuration

PAD	FUNCTION
1	CATHODE
2	ANODE
3	THERMAL

Note:

The thermal pad is electrically isolated from anode and cathode.

Recommended PCB

Recommended Star PCB

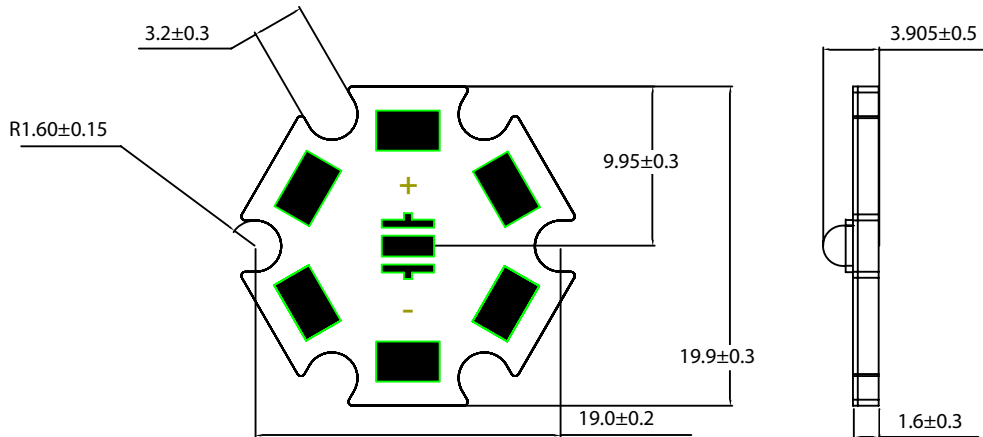

Recommended Solder Pad

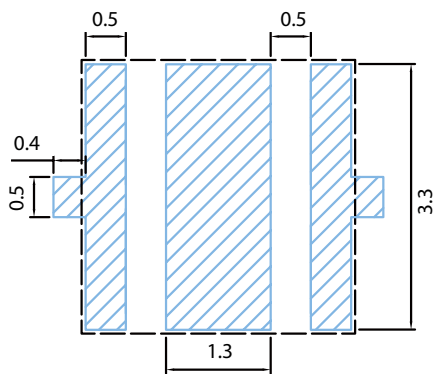

Notes:

1. All dimensions are measured in mm.
2. Drawings are not to scale.

Characteristic Curve

Color Spectrum

($I_{rel}=f(\lambda); I_F = 350\text{mA}; T_J = 25^\circ\text{C}$)

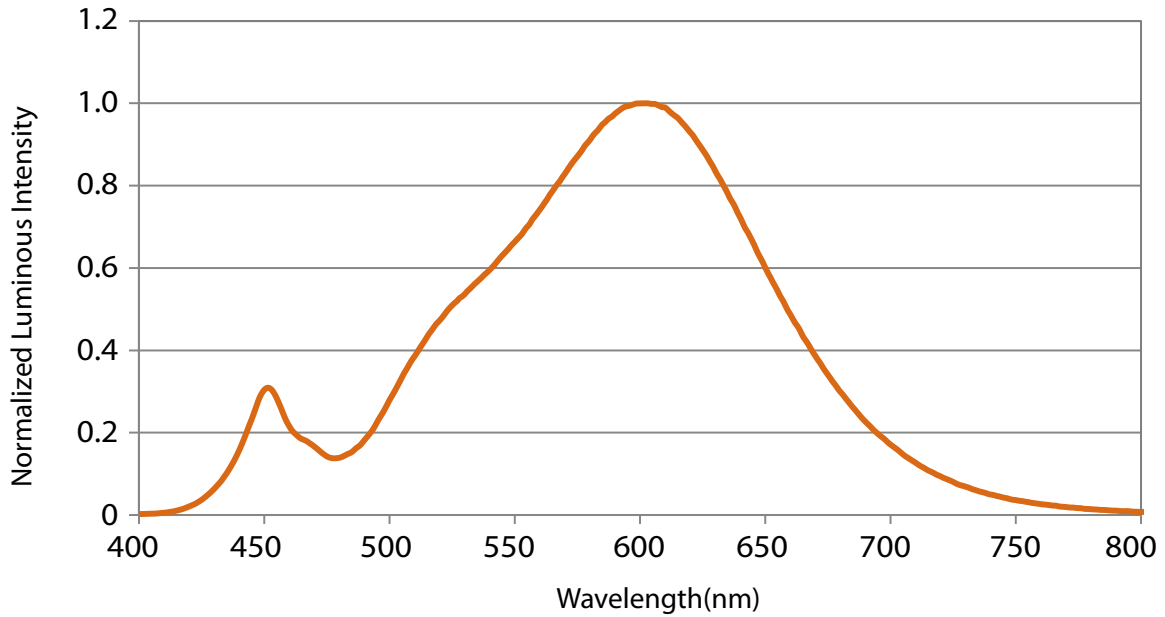

Beam Pattern

($I_F = 350\text{mA}; T_J = 25^\circ\text{C}$)

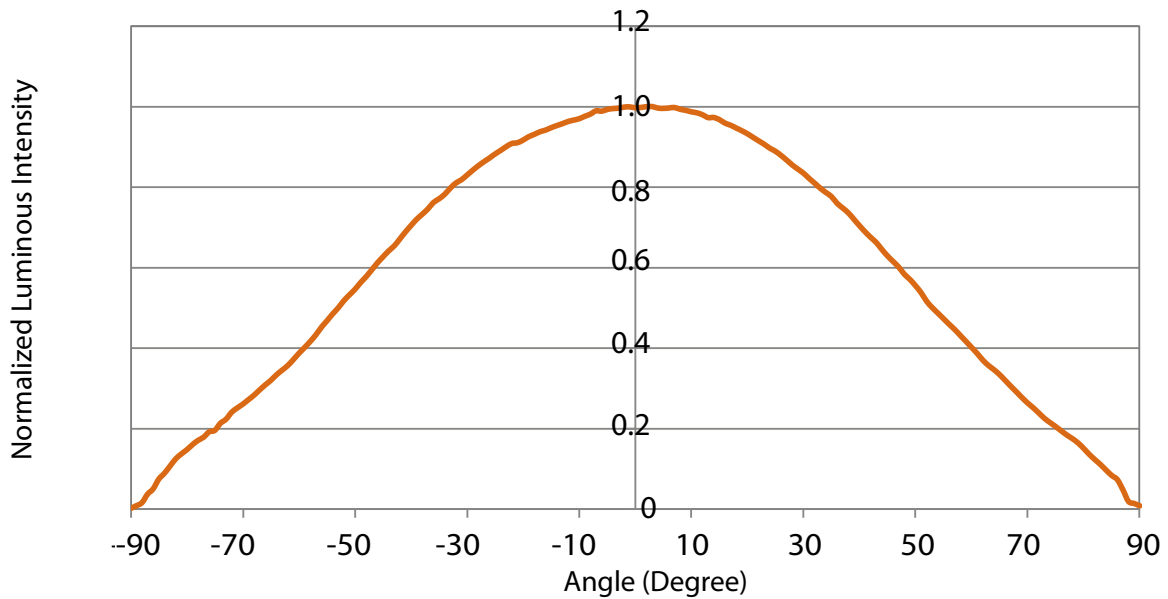

Forward Current vs. Forward Voltage

$(I_F = f(V_F); T_J = 25^\circ\text{C})$

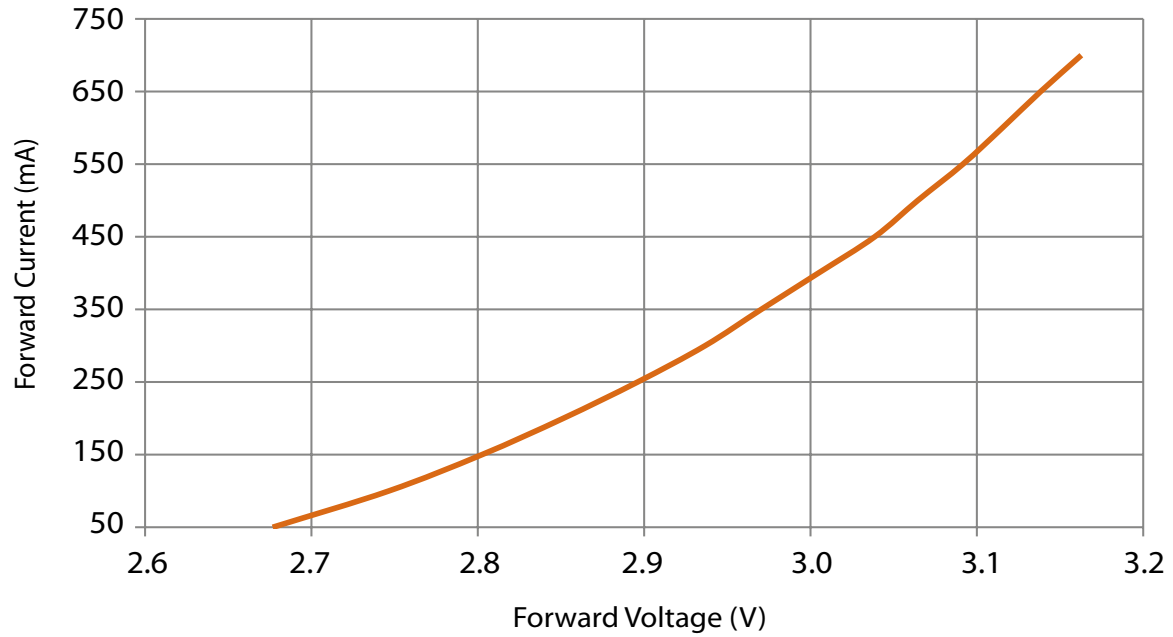

Relative Luminous Intensity vs. Forward Current

$(I_V/I_V(350\text{mA}) = f(I_F); T_J = 25^\circ\text{C})$

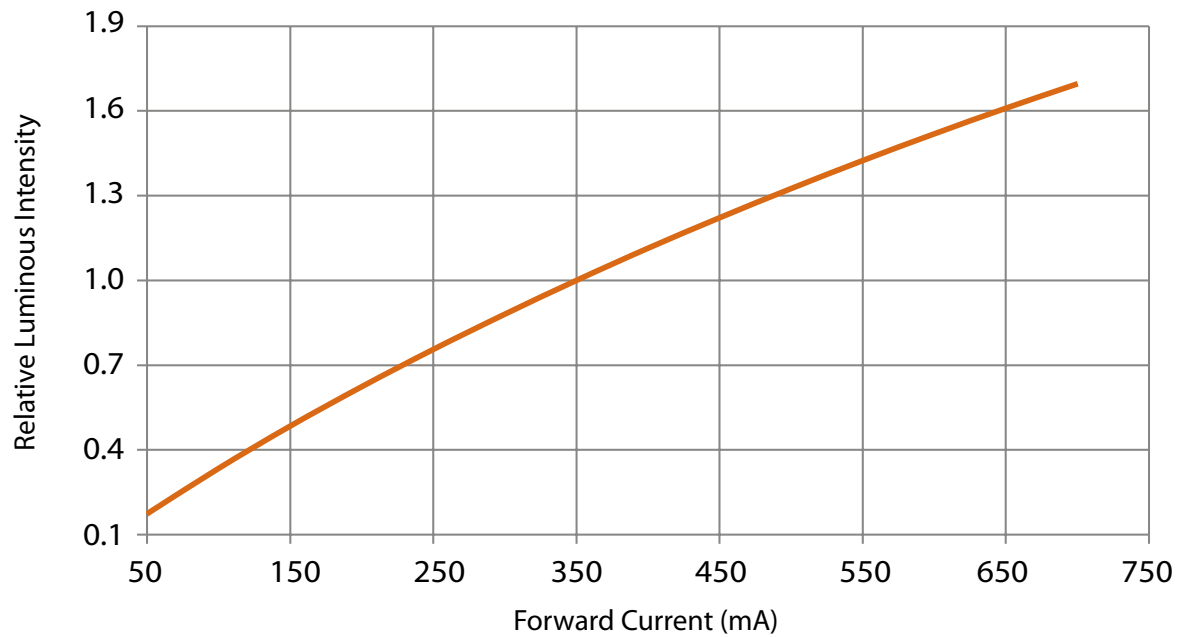

$\Delta C_x, \Delta C_y$ vs. Forward Current

$(\Delta C_x, \Delta C_y = f(I_f); T_j = 25^\circ\text{C})$

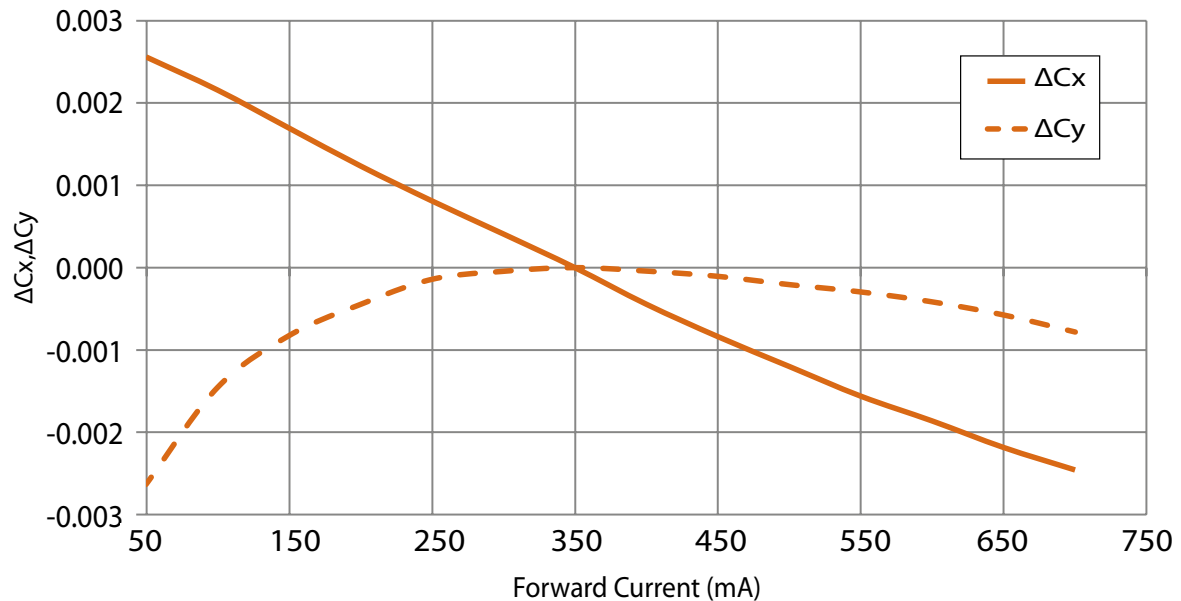

Relative Luminous Flux vs. Junction Temperature

$(I_f/I_f(25^\circ\text{C}) = f(T_j); I_f = 350\text{mA})$

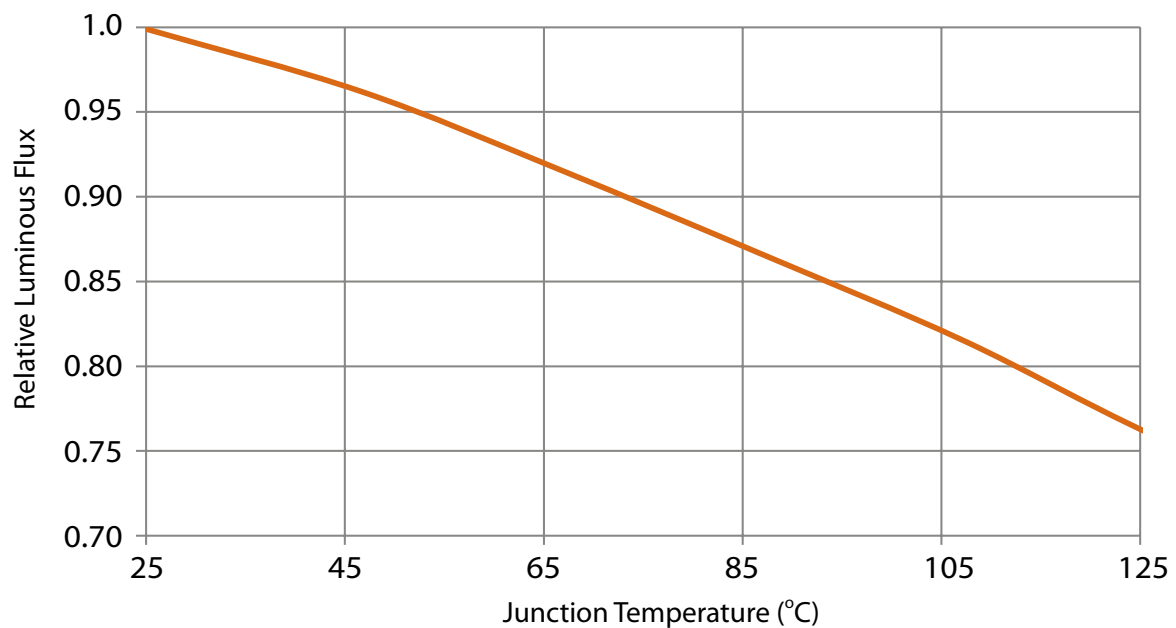

Forward Voltage vs. Junction Temperature

$(\Delta V_f = V_f - V_f(25^\circ\text{C}) = f(T_j); I_f = 350\text{mA})$

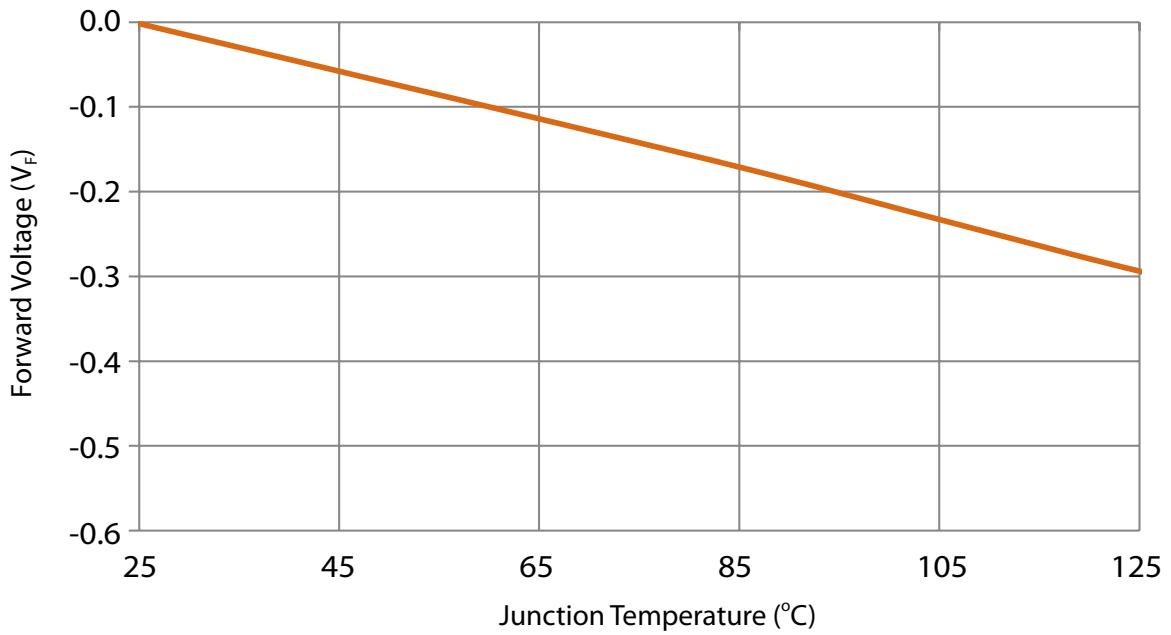

$\Delta C_x, \Delta C_y$ vs. Junction Temperature

$(\Delta C_x, \Delta C_y = f(T_j); I_f = 350\text{mA})$

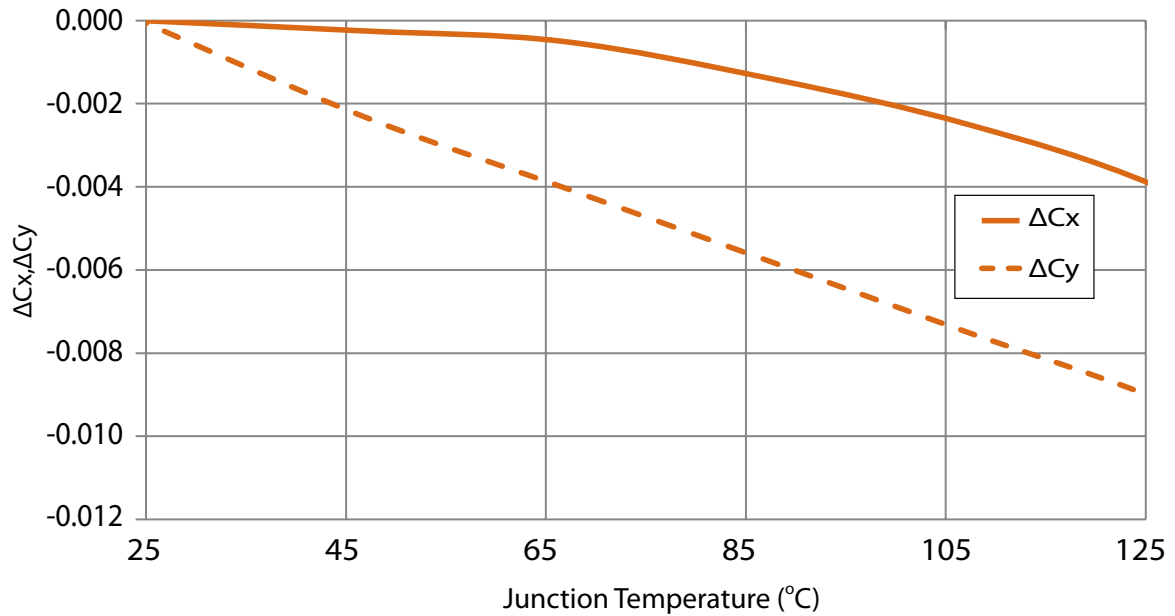

Forward Current vs. Solder Temperature

$I_f = f(T)$

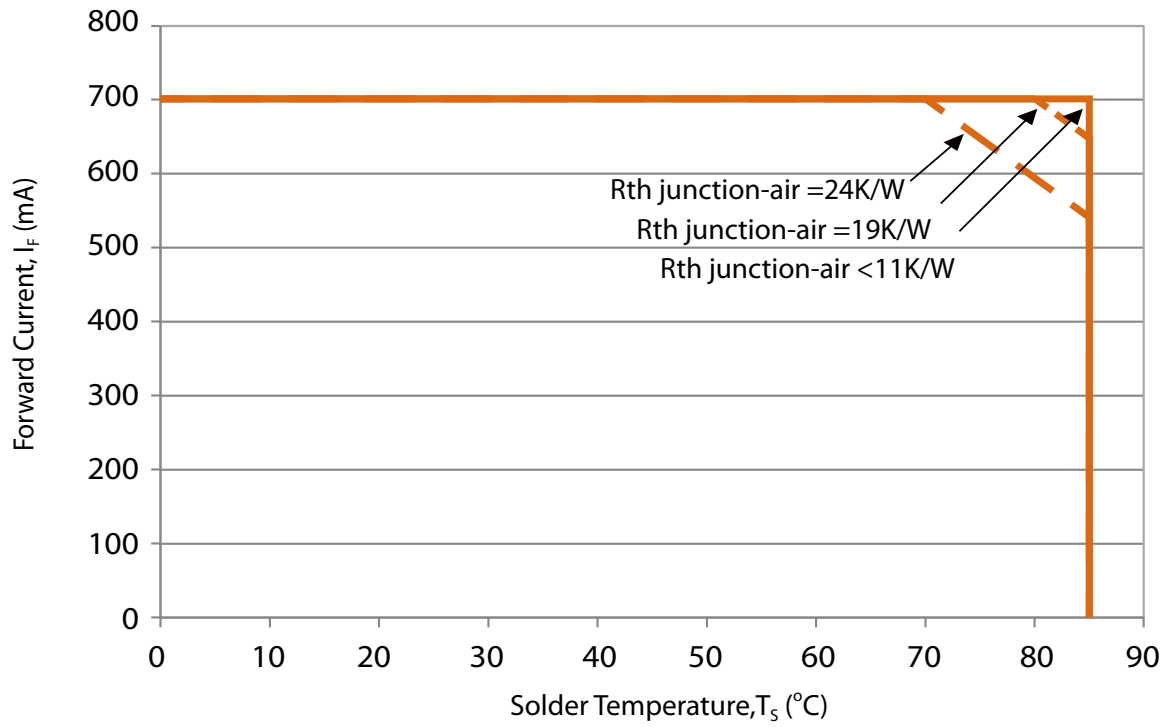

Reflow Profile

The following reflow profile is from IPC/JEDEC J-STD-020D which provided here for reference.

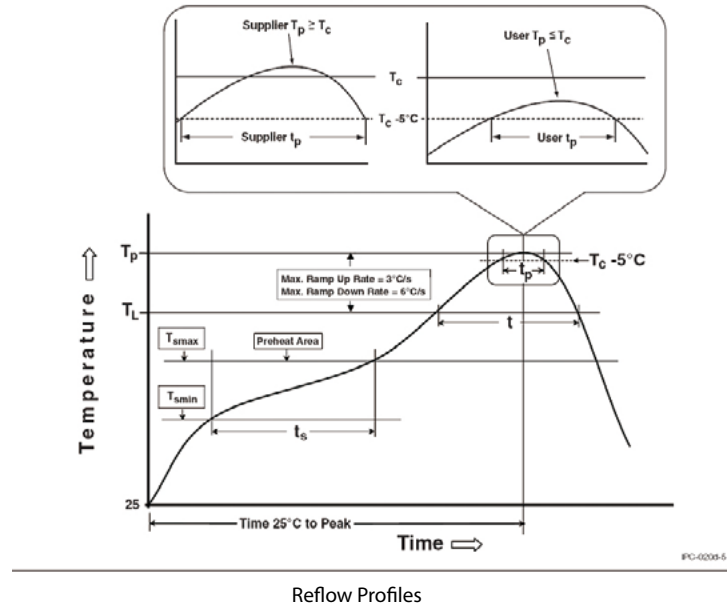

Reflow Profiles

Classification Reflow Profiles

Profile Feature	Pb-Free Assembly
Preheat & Soak Temperature min (T_{smin}) Temperature max (T_{smax}) Time (T_{smin} to T_{smax}) (ts)	150 °C 200 °C 60-120 seconds
Average ramp-up rate (T_{smax} to T_p)	3 °C/second max.
Liquidous temperature (T_L) Time at liquidous (t_L)	217 °C 60-150 seconds
Peak package body temperature (T_p)*	255 °C ~260 °C *
Classification temperature (T_C)	260 °C
Time (t_p)** within 5 °C of the specified classification temperature (T_C)	30** seconds
Average ramp-down rate (T_p to T_{smax})	6°C/second max.
Time 25°C to peak temperature	8 minutes max.

Notes:

- * Tolerance for peak profile temperature (T_p) is defined as a supplier minimum and a user maximum.
- ** Tolerance for time at peak profile temperature (t_p) is defined as a supplier minimum and a user maximum.

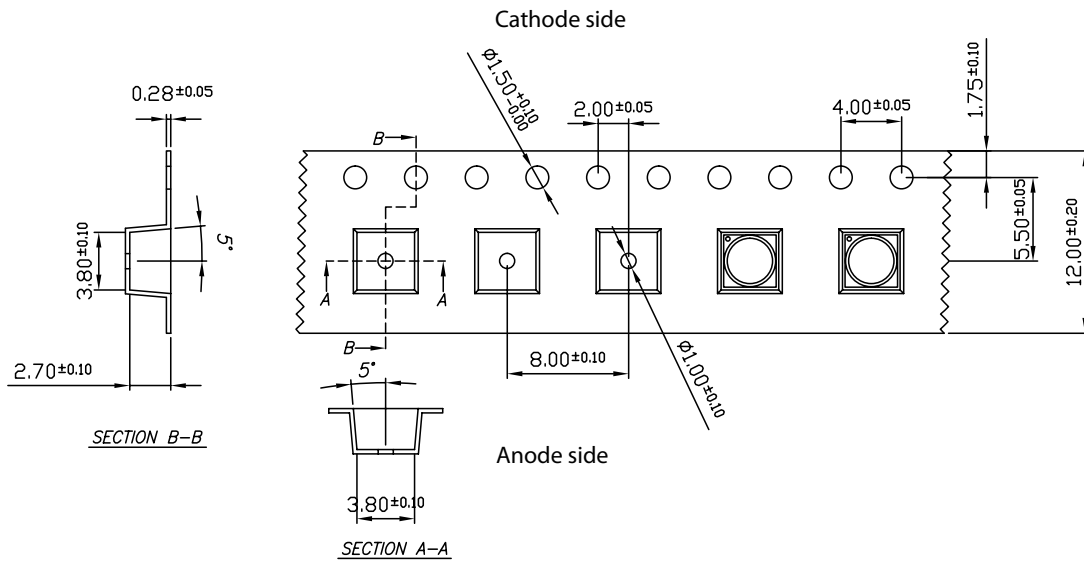

Product Packaging Information

Tapping



Product Label

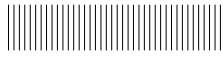

P/N : XXXXXXXXXXXX

 Group : XXXXXXXXXXXX

 Lot No : XXXXXXXXXXXX

 MMMMMMMMMMMM



QTY : XXX

 QC : OQC1
 Color : XXXXX

Label information

P/N : Order Code
 Group : BIN Code
 Lot No : Lot Number
 QTY : Packing Quantity

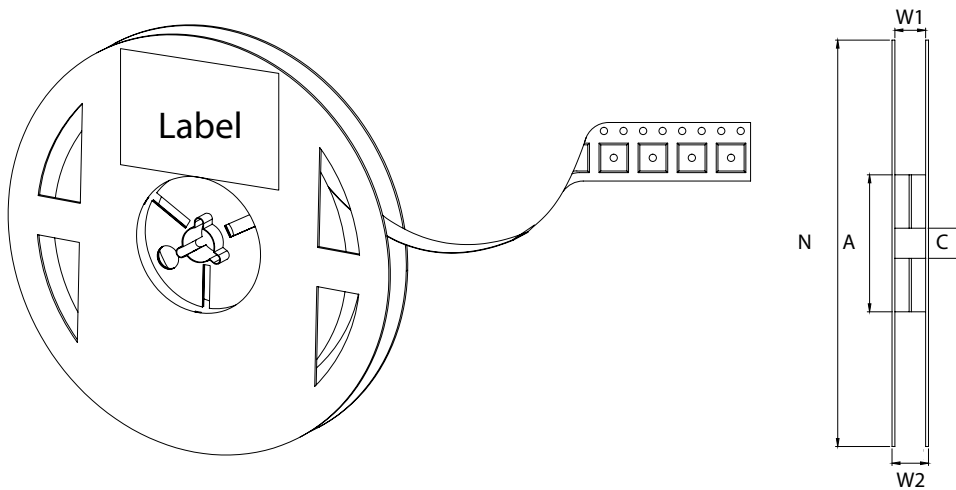
Tape and Reel



A	C	N	W1	W2	Pieces per Reel
178±1	13.2±0.2	60±0.5	13.5±0.5	16+0.5/-0	≤ 500
Starting with 50pcs empty, and 50pcs empty at the last.					

Static Bag

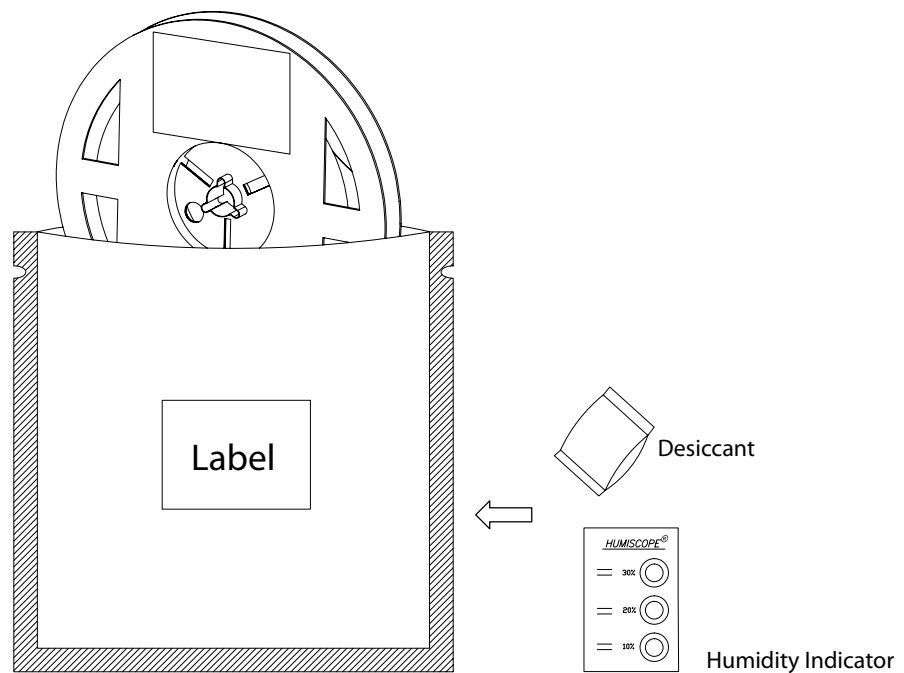

Revision History

Versions	Description	Release Date
1	Establish order code information	2020/07/02

About Edison Opto

Edison Opto is a leading manufacturer of high power LED and a solution provider experienced in LDMS. LDMS is an integrated program derived from the four essential technologies in LED lighting applications- Thermal Management, Electrical Scheme, Mechanical Refinement, Optical Optimization, to provide customer with various LED components and modules. More Information about the company and our products can be found at www.edison-opto.com

Copyright©2020 Edison Opto. All rights reserved. No part of publication may be reproduced or transmitted in any form or by any means, electronic or mechanical, including photo copy, recording or any other information storage and retrieval system, without prior permission in writing from the publisher. The information in this publication are subject to change without notice.

www.edison-opto.com

For general assistance please contact:
service@edison-opto.com.tw

For technical assistance please contact:
LED.Detective@edison-opto.com.tw